

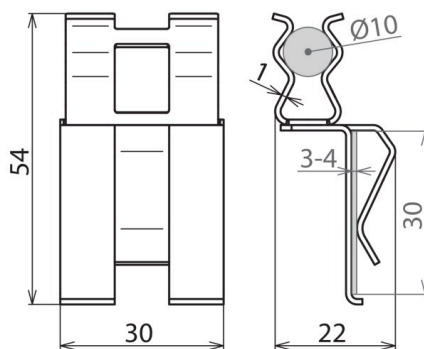

DC BK 10 FL30 STBLANK (308 142)



Figure without obligation



- Compact, light and resource-saving
- Quick and without tools
- Efficient and time-saving

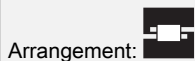

Type	DC BK 10 FL30 STBLANK
Part No.	308 142
Material	St/bare
Clamping range Rd* / Fl	10 / 30 mm
Material thickness (t1)	1 mm
Short-circuit current (a.c. 50 Hz / d.c.) (1 s; ≤ 300 °C)	2.3 kA
Lightning current carrying capability (10/350 µs)	50 kA**
Standard	EN 62561-1
Weight	18 g
Customs tariff number (Comb. Nomenclature EU)	85359000
GTIN	4013364288522
PU	50 pc(s)

* Nominal diameter d_s of the reinforcement

** For exact assignment see test certificate.

We reserve the right to introduce changes in performance, configuration and technology, dimensions, weights and materials in the course of technical progress. The figures are shown without obligation.