



DEHN

Surge protection for Fire Alarm Systems (FAS)

White Paper



Content

- Lightning and overvoltage hazards
- Normative aspects and legal regulations
- Components of a fire alarm system
- Fire alarm control panel
- Fire brigade key depot
- Direct/indirect shielding
- Wiring information
- Protected/unprotected cable installation

Surge protection for Fire Alarm Systems (FAS)

White Paper



Technical fire protection equipment and especially fire alarm systems are considered to be of great importance. They enable modern buildings with elaborate architecture and both a complex infrastructure and purpose to easily meet today's fire protection and safety requirements. The systems are used for fire detection, alarming and evacuation and thus serve the protection of people and material assets. A further critical task as a superordinate system element is to take over the central function of the control systems of other safety-related systems and equipment in the event of fire. Satisfactory fulfilment of these demanding requirements means that a detailed synchronisation of all parties involved, coordination of the interfaces and appropriate documentation of all measures are essential. The fire detection and alarm concept must concretely define such things as the protection objectives of the operator as well as possible requirements under building law which, for example, can result from a special building regulation, a building permit or a required fire protection strategy. It describes the necessary requirements and brings them in line with the normative specifications and generally accepted engineering practices. It thus contributes to the safe planning, execution and subsequent operation of the systems. Insurance regulations that require compliance with the current VdS (German Property Insurance Association) inspection agency guidelines under contract law should also be taken into account.

Lightning and overvoltage hazards

Lightning strikes and voltage surges can cause irreparable damage to electrical and electronic equipment that is not adequately protected. In addition to electrical consumers and telecommunications equipment, this applies to safety systems such as fire alarm and voice alarm systems. The damage not only includes purely material losses but, above all, consequential damage such as loss of production, loss of data or the appointment of a fire watch should the fire alarm system fail. Even people not warned in time or at all are in severe danger in case of fire.

Since safety technology protects people and material assets, it must be guarded especially well against failure due to lightning and surges. This also prevents false alarms which are problematic in a number of respects:

- ➔ If there is an accumulation of false alarms, the operator can no longer rely on the system and will question the point of it and the investment it entails
- ➔ Security staff or fire fighters may stop responding to alarms
- ➔ Neighbours are disturbed by the acoustic alarms
- ➔ Emergency services (e.g. fire brigade) are called out unnecessarily

- ➔ If fire extinguishing systems are triggered, business operations are interrupted or electrical equipment may be destroyed

However, the failure of fire protection equipment in the event of a direct lightning strike is particularly critical because, in this case, the probability of a fire breaking out is significantly increased.

Small surges can also cause damage to safety-related systems and this is sometimes difficult to detect. According to the statistics gathered by insurers of electronic equipment in Germany, the most frequent cause of damage is the occurrence of overvoltage. According to the German Insurance Association (GDV), the total damage sum in 2018 was over 280 million Euros. One of the main causes of surges is direct or remote lightning effects. Surges due to direct strikes in a building structure generate the most severe damage. With over 4 million lightning strikes registered every year in Germany (as of 2017; Siemens' lightning information service BLIDS), overvoltage effects must be expected frequently, especially in large networks.

Normative aspects and other regulations

Precautions should be taken to avoid false alarms or even the possible destruction of the fire alarm system due to atmospheric surges and the effects of thunderstorms. In many countries building codes or other regulations insist on FAS for specific building types or building occupancies. Minimum measures for buildings without external lightning protection systems have been defined by IEC 60364-4-44 since October 2016. This standard describes mandatory measures for the power supply lines leading into a building. IEC 60364-4-44 recommends rather than requires surge protection measures for Internet, telephone and broadband cable lines. According to VdS 2833 (see also DIN VDE 0845-1), shielding and earthing measures for alarm systems should be carried out as well. Clarification is also necessary as to whether surge arresters are required based on the indicators listed in the VdS 2833 guideline. If this is the case, the operator of the alarm system must be informed of the need to implement the protective measures. If lightning protection is not prescribed by legal or official regulations, a risk analysis can help to clarify the need for and the protection class of a lightning protection system designed to avert potential hazards with possibly devastating effects.

If surge arresters are used in buildings with external lightning protection systems, VdS 2833 stipulates that they must be installed at the corresponding transitions between the respective lightning protection zones.

Related documents in Germany:

- ➔ VdS 2010: Risk-Based Lightning and Surge Protection

Surge protection for Fire Alarm Systems (FAS)

White Paper

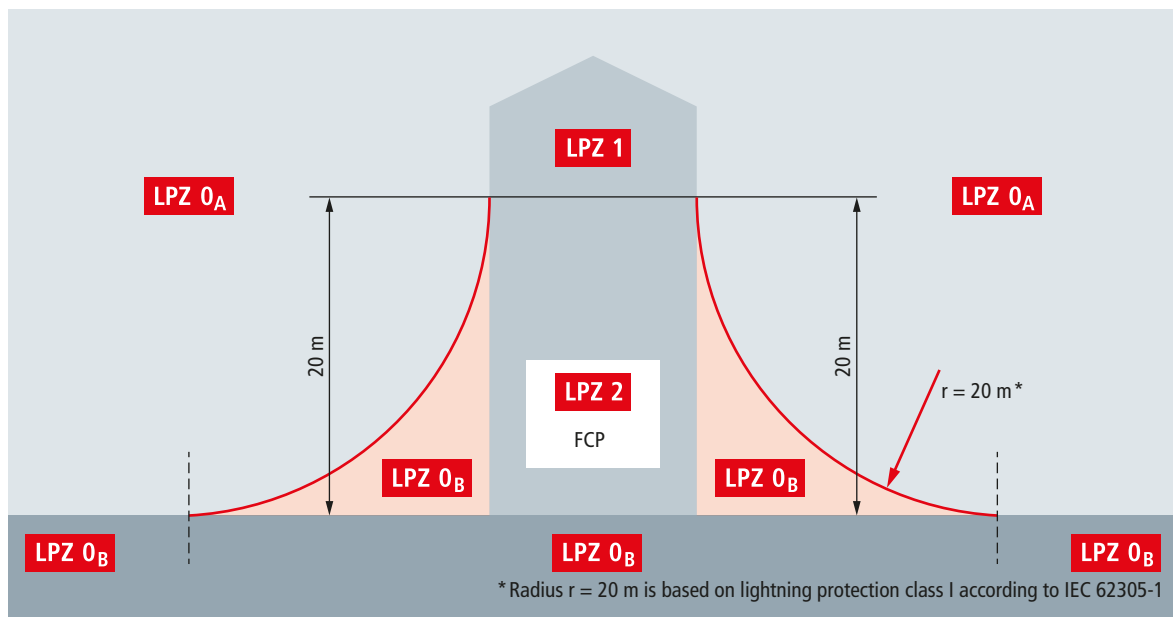

Figure 1 Installation zones for lightning and surge arresters according to VdS 2833

- ➔ VdS 2031: Lightning and Surge Protection in Electrical Systems
- ➔ VdS 2833: Protective Measures Against Overvoltage for Alarm Systems
- ➔ VdS 5054: Assistance in Dealing With Damage After Lightning Strikes / Overvoltage

Components of a fire alarm system Fire Alarm System (FAS)

Fire alarm systems should protect people and animals as well as facilities and buildings against fire and smoke. This also includes rapid alerting of the fire brigade and localisation of hazard zones as well as swift evacuation. In accordance with these protection objectives, a fire alarm system takes over the reception, processing and display of fire and fault messages as well as control of alarm, transmission and fire-protection systems.

To address all these issues, a system is equipped with the following functional components:

- ➔ Fire Alarm Control Panel (FACP)
- ➔ Automatic detectors and sensors / manual call points
- ➔ Signal lines and radio connections
- ➔ Display and operating devices
- ➔ Alarm signalling devices
- ➔ Control devices

Fire alarm control panel

The heart of the fire alarm system is the Fire Alarm Control Panel (FACP). Here, all incoming information is monitored, checked, evaluated and processed up to and including the automatic initiation of necessary measures.

Depending on the size of the fire alarm system, either freely configurable devices or ready-made compact control panels are used.

Based on the Lightning Protection Zone (LPZ) concept according to IEC 62305-4, the building is divided into what are known as installation zones in accordance with the guideline VdS 2833. Appropriate SPDs (Surge Protective Devices) are then employed at the transitions between zones to achieve the protection objectives for the system. In order to meet the requirement for high availability for a fire alarm control panel, the control panel itself is assigned a separate zone (usually LPZ 2) (Figure 1). This means that all lines to and from the control panel must be protected by surge arresters.

A corresponding protection concept for all components of a fire alarm system is shown in Figure 2.

Fire brigade key depot (FSD)

In case of an emergency, the fire brigade peripheral devices should quickly and reliably inform the fire brigade about the location of the fire as well as access and escape routes. In addition, peripheral fire brigade devices make it possible to enter the building without force in case of an emergency. One of these is the fire brigade key depot (figure: FSD), a lock box

Surge protection for Fire Alarm Systems (FAS)

White Paper

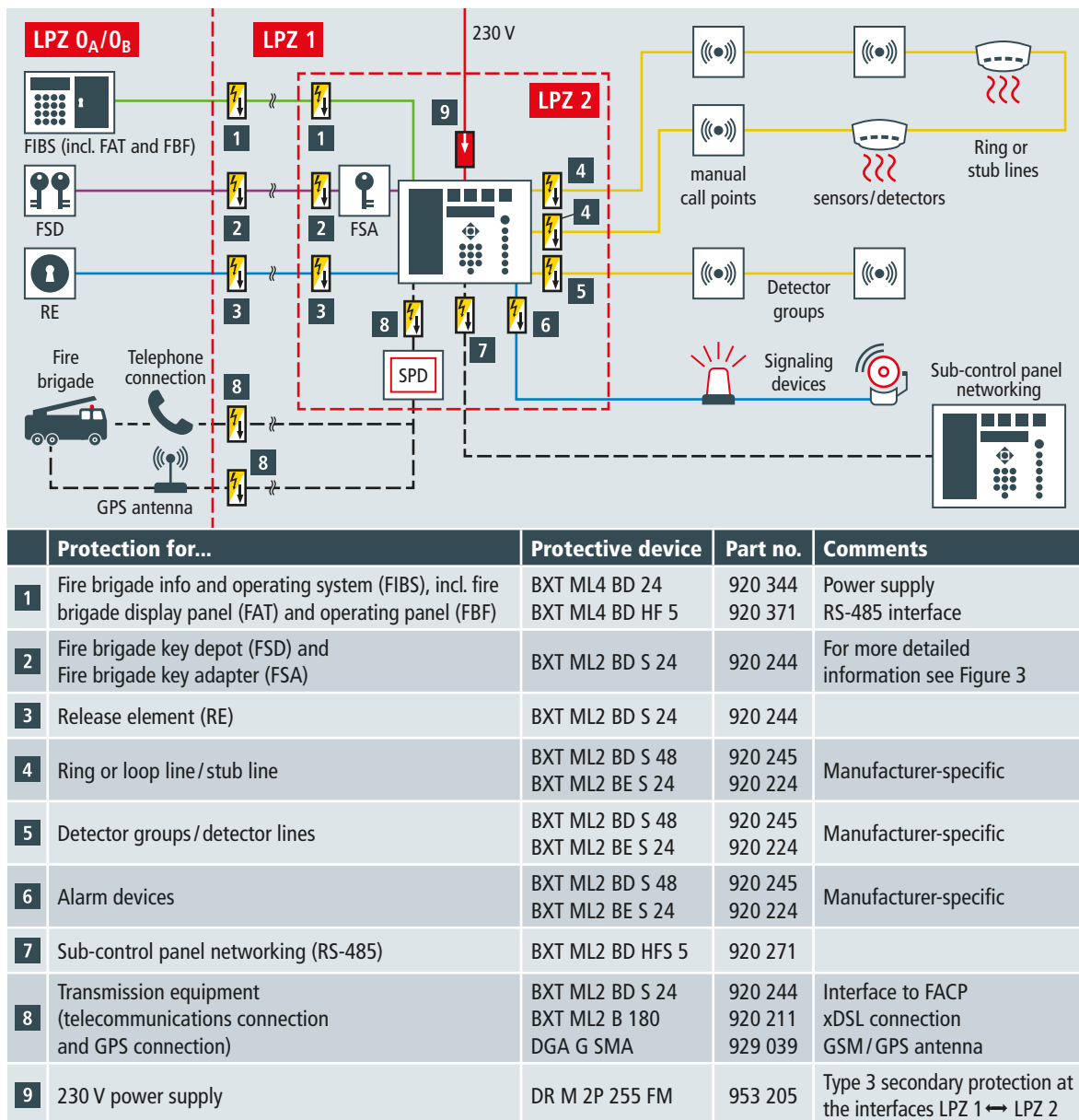

Figure 2 Lightning and surge protection concept of a fire alarm system utilising installation zones according to Vds 2833

for keeping the key to the building located at the entrance. In the event of a fire alarm for the fire brigade, the key depot is unlocked to provide the emergency services a means of non-forced entry into the building for the purpose of firefighting. Fire brigade key depot, key depot columns and release elements must be connected to the building's equipotential bonding with a cross-section of at least 4 mm². If the key de-

pot/key depot column is located in the area of LPZ 0_A prone to lightning strikes, the devices must be connected directly to the equipotential bonding/earthing system with a copper conductor of at least 16 mm² capable of sustaining lightning current.

All conductors must be protected with surge protective devices in dependence on the location of the key depot/key depot col-

Surge protection for Fire Alarm Systems (FAS)

White Paper

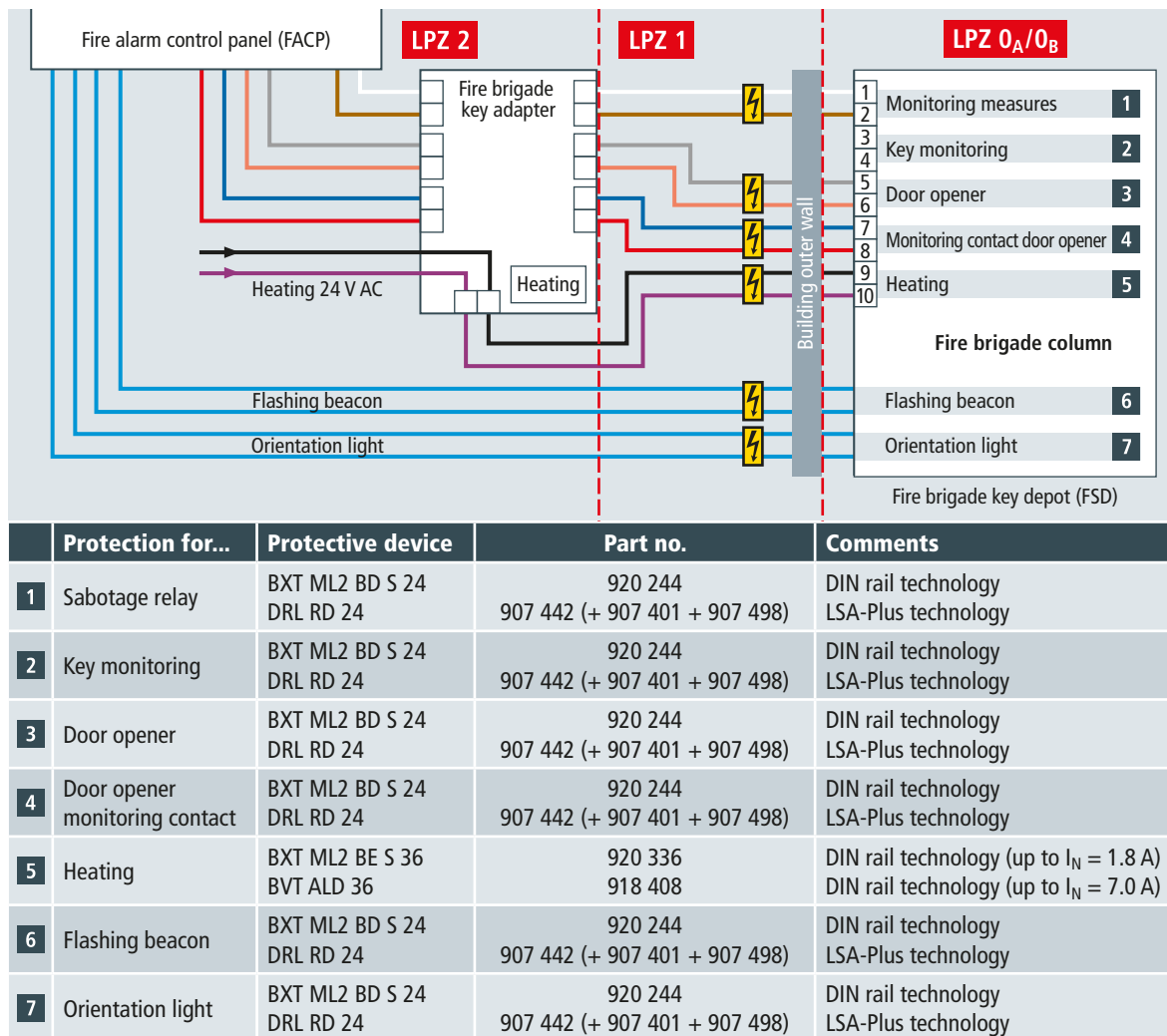

Figure 3 Lightning and surge protection concept for the fire brigade key depot (FSD)

um. A surge protection concept for a fire brigade key depot can be found in **Figure 3**.

Wiring information

In addition to correct selection of the surge protection devices, safe and functional wiring and line installation as well as proper connection of the shield and the drain wires are important and should not be neglected.

Direct/indirect shielding of the drain wire

Usually, drain wires are earthed directly at the FACP (Fire Alarm Control Panel) or are already earthed via the module. This means that the shield does not have to be earthed

additionally at the FACP. In its further course it must not be connected directly to earth potential in order to avoid fault messages or problems on the signal/ring conductors. Consequently, indirect shield earthing is required for lightning equipotential bonding. This can be accomplished, for example, using appropriate SPD's equipped via so called gas discharge tubes.

Another aspect of indirect shield earthing is the avoidance of equalising currents caused by two separate earthing systems. To prevent equalising currents via equipotential bonding, only one end of the shield must be connected directly to earth potential (**Figure 4**: Building A). The other end is earthed indirectly by means of a gas discharge tube (**Figure 4**: Building B).

Surge protection for Fire Alarm Systems (FAS)

White Paper

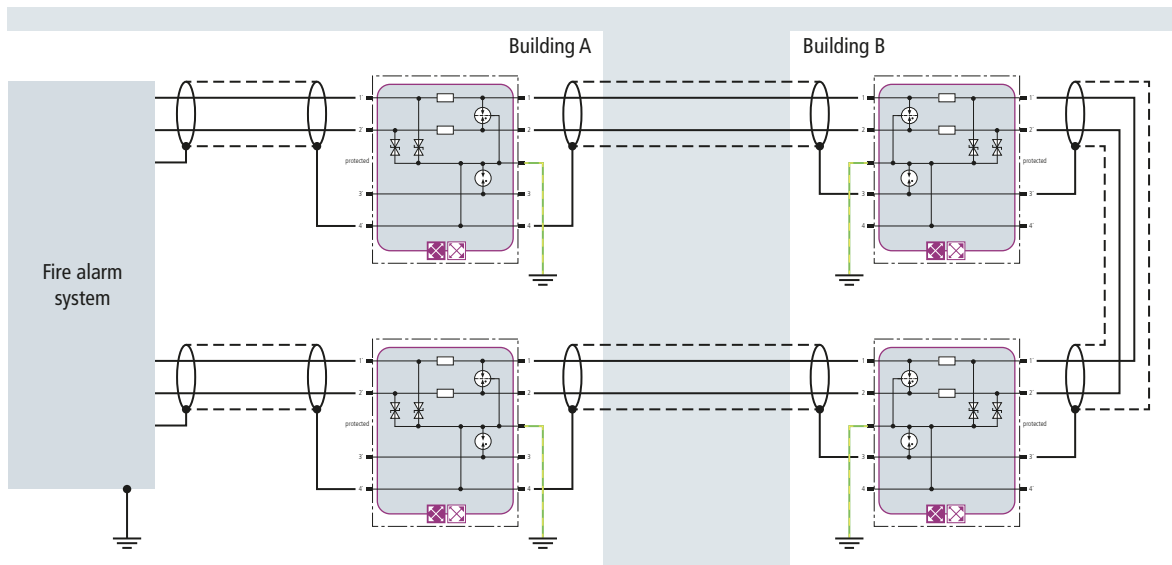

Figure 4 SPD direct/indirect shield earthing with BLITZDUCTOR XT ML2 for cables across several buildings with different earth potentials

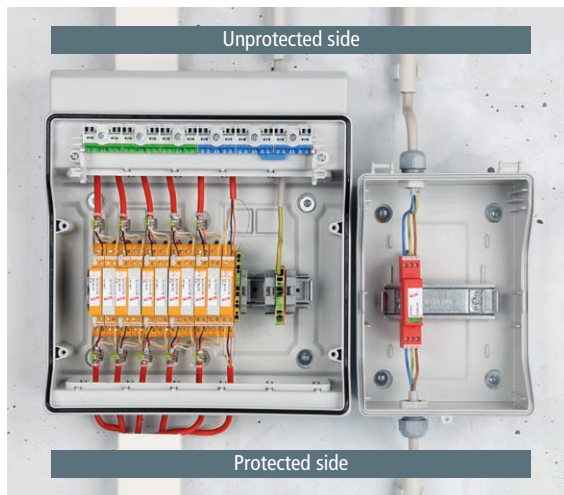

Figure 5 Separate cable routing of power and information technology cables according to IEC 60364-4-44

Protected/unprotected cable installation

Despite well-executed equipotential bonding, incorrect cable routing can lead to an impairment of the protective effect or even damage to the end device. If strict spatial separation or shielding of an unprotected line upstream of the SPD and a protected line downstream of the SPD is not observed, the electromagnetic interference field can cause interference impulse to be coupled into the protected side of the cable.

IEC 60364-4-44 describes various installation instructions for cable installation, such as avoiding the formation of loops, separate routing of power supply and information technology cables as well as the separation of protected and unprotected cables. **Figure 5** further illustrates this installation information.

Conclusion

Fire alarm systems report the occurrence of hazardous situations in the area being monitored. As safety devices, high demands are placed on the technology with respect to safe operation and the prevention of false alarms. The described protective measures against overvoltage caused by lightning strikes and switching operations contribute to achieving this objective. Forced by regulations and authorities in many countries appropriate protection is required. Optimal protection against the damaging effects of lightning and surges is achieved through coordinated measures of external and internal lightning protection and suitable approved SPDs.

DEHNrail

DR M 2P 255 FM (953 205)

- Two-pole surge arrester consisting of a base part and a plug-in protection module
- High discharge capacity due to heavy-duty zinc oxide varistor / spark gap combination
- Energy coordination with other arresters of the Red/Line product family



Figure without obligation

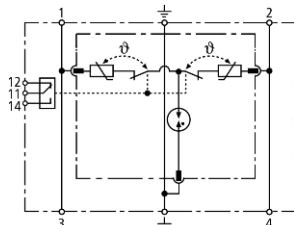

Basic circuit diagram DR M 2P 255 FM

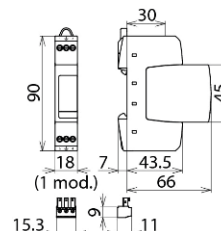

Dimension drawing DR M 2P 255 FM

Two-pole surge arrester consisting of a base part and a plug-in protection module; with floating remote signalling contact.

Type	DR M 2P 255 FM
Part No.	953 205
SPD according to EN 61643-11 / IEC 61643-11	type 3 / class III
Nominal voltage (a.c.) (U_N)	230 V (50 / 60 Hz)
Max. continuous operating voltage (a.c.) (U_C)	255 V (50 / 60 Hz)
Max. continuous operating voltage (d.c.) (U_C)	255 V
Nominal load current (a.c.) (I_L)	25 A
Nominal discharge current (8/20 μ s) (I_n)	3 kA
Total discharge current (8/20 μ s) [L+N-PE] (I_{total})	5 kA
Combination wave (U_{OC})	6 kV
Combination wave [L+N-PE] ($U_{OC total}$)	10 kV
Voltage protection level [L-N] / [L/N-PE] (U_P)	≤ 1250 / ≤ 1500 V
Response time [L-N] (t_A)	≤ 25 ns
Response time [L/N-PE] (t_A)	≤ 100 ns
Max. mains-side overcurrent protection	25 A gG or B 25 A
Short-circuit withstand capability for mains-side overcurrent protection with 25 A gG (I_{SCCR})	6 kA _{rms}
Temporary overvoltage (TOV) [L-N] (U_T) – Characteristic	335 V / 5 sec. – withstand
Temporary overvoltage (TOV) [L-N] (U_T) – Characteristic	440 V / 120 min. – safe failure
Temporary overvoltage (TOV) [L/N-PE] (U_T) – Characteristic	335 V / 120 min. – withstand
Temporary overvoltage (TOV) [L/N-PE] (U_T) – Characteristic	440 V / 5 sec. – withstand
Temporary overvoltage (TOV) [L+N-PE] (U_T) – Characteristic	1200 V + U_{REF} / 200 ms – safe failure
Operating temperature range (T_U)	-40 °C ... +80 °C
Operating state / fault indication	green / red
Number of ports	1
Cross-sectional area (min.)	0.5 mm ² solid / flexible
Cross-sectional area (max.)	4 mm ² solid / 2.5 mm ² flexible
For mounting on	35 mm DIN rails acc. to EN 60715
Enclosure material	thermoplastic, red, UL 94 V-0
Place of installation	indoor installation
Degree of protection	IP 20
Capacity	1 module(s), DIN 43880
Approvals	KEMA, VDE, UL, CSA
Type of remote signalling contact	changeover contact
Switching capacity (a.c.)	250 V / 0.5 A
Switching capacity (d.c.)	250 V / 0.1 A; 125 V / 0.2 A; 75 V / 0.5 A
Cross-sectional area for remote signalling terminals	max. 1.5 mm ² solid / flexible
Weight	84 g
Customs tariff number (Comb. Nomenclature EU)	85363030
GTIN	4013364108318
PU	1 pc(s)

BLITZDUCTOR VT

BVT ALD 36 (918 408)

- For d.c. supply systems up to nominal currents of 7 A
- Low voltage protection level
- For installation in conformity with the lightning protection zone concept at the boundaries from $0_A -2$ and higher



Figure without obligation

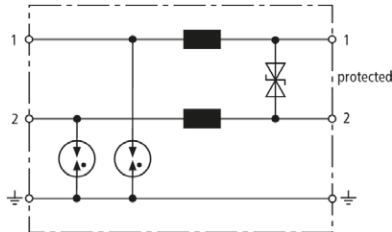

Basic circuit diagram BVT ALD 36

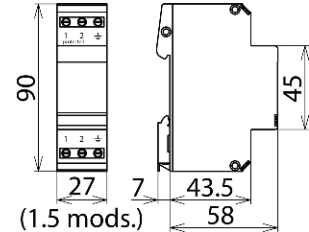

Dimension drawing BVT ALD 36

Energy-coordinated, DIN rail mounted combined lightning current and surge arrester for protecting unearthed d.c. power supply systems.

Type	BVT ALD 36
Part No.	918 408
SPD class	TYPE 1 Pt
Nominal voltage (d.c.) (U_N)	36 V
Max. continuous operating voltage (d.c.) (U_C)	45 V
Nominal current at 80 °C (I_L)	4 A
Nominal current at 45 °C (I_L)	7 A
D1 Lightning impulse current (10/350 μ s) per line (I_{imp})	2.5 kA
D1 Total lightning impulse current (10/350 μ s) (I_{imp})	5 kA
C2 Nominal discharge current (8/20 μ s) per line (I_n)	10 kA
C2 Total nominal discharge current (8/20 μ s) (I_n)	20 kA
Voltage protection line-line for I_n C2 (U_p)	≤ 80 V
Voltage protection level line-PG for I_n C2 (U_p)	≤ 1000 V
Voltage protection level line-line at 1 kV/ μ s C3 (U_p)	≤ 60 V
Voltage protection level line-PG at 1 kV/ μ s C3 (U_p)	≤ 650 V
Series resistance per line	22 μ H
Capacitance line-line (C)	≤ 1.5 pF
Capacitance line-PG (C)	≤ 100 pF
Operating temperature range (T_U)	-40 °C ... +80 °C
Degree of protection	IP 20
For mounting on	35 mm DIN rails acc. to EN 60715
Connection (input / output)	screw / screw
Cross-sectional area, solid	0.5-6.0 mm ²
Cross-sectional area, flexible	0.5-4.0 mm ²
Tightening torque (terminals)	0.8 Nm
Earthing via	screw terminal
Enclosure material	thermoplastic, UL 94 V-0
Colour	yellow
Test standards	IEC 61643-21 / EN 61643-21
Approvals	UL, EAC
Weight	110 g
Customs tariff number (Comb. Nomenclature EU)	85363010
GTIN	4013364125292
PU	1 pc(s)

BLITZDUCTOR XT

BXT ML2 B 180 (920 211)

- LifeCheck SPD monitoring function
- Two-pole lightning equipotential bonding with four terminals for shield and/or functional earthing
- For installation in conformity with the lightning protection zone concept at the boundaries from $0_A - 1$ and higher



Figure without obligation

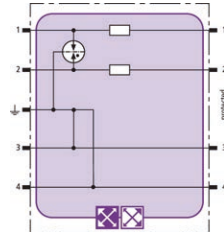

Basic circuit diagram BXT ML2 B 180

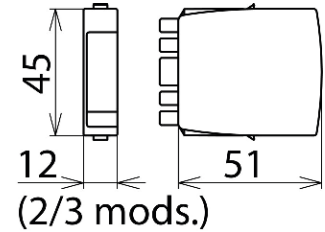

Dimension drawing BXT ML2 B 180

Space-saving two-pole lightning current arrester module with LifeCheck feature and shield earthing for almost all applications. For use in conjunction with downstream **TYPE2P1** surge arresters or combined lightning current and surge arresters with a lower or equal voltage level. If LifeCheck detects thermal or electrical overload, the arrester has to be replaced. This status is indicated contactlessly by the DEHNrecord LC / SCM / MCM reader.

Type	BXT ML2 B 180
Part No.	920 211
SPD monitoring system	LifeCheck
SPD class	TYPE2P1
Nominal voltage (U_N)	180 V
Max. continuous operating voltage (d.c.) (U_c)	180 V
Max. continuous operating voltage (a.c.) (U_c)	127 V
Nominal current at 45 °C (I_L)	1.2 A
D1 Total lightning impulse current (10/350 μ s) (I_{imp})	10 kA
D1 Lightning impulse current (10/350 μ s) per line (I_{imp})	2.5 kA
C2 Total nominal discharge current (8/20 μ s) (I_n)	20 kA
C2 Nominal discharge current (8/20 μ s) per line (I_n)	10 kA
Voltage protection level line-line for I_{imp} D1 (U_p)	≤ 600 V
Voltage protection level line-PG for I_{imp} D1 (U_p)	≤ 550 V
Voltage protection level line-line at 1 kV/ μ s C3 (U_p)	≤ 650 V
Voltage protection level line-PG at 1 kV/ μ s C3 (U_p)	≤ 550 V
Series resistance per line	0.4 ohm(s)
Capacitance line-line (C)	≤ 16 pF
Capacitance line-PG (C)	≤ 16 pF
Operating temperature range (T_u)	-40 °C ... +80 °C
Degree of protection (with plugged-in protection module)	IP 20
Pluggable into	BXT BAS / BSP BAS 4 base part
Earthing via	BXT BAS / BSP BAS 4 base part
Enclosure material	polyamide PA 6.6
Colour	yellow
Test standards	IEC 61643-21 / EN 61643-21, UL 497B
Approvals	CSA, EAC, ATEX, IECEx, CSA & USA Hazloc, SIL
SIL classification	up to SIL3 ^{*)}
ATEX approvals	DEKRA 11ATEX0089 X: II 3 G Ex nA IIC T4 Gc
IECEx approvals	DEK 11.0032X: Ex nA IIC T4 Gc
CSA & USA Hazloc approvals (1)	2516389: Class I Div. 2 GP A, B, C, D T4
CSA & USA Hazloc approvals (2)	2516389: Class I Zone 2, AEx nA IIC T4
Weight	23 g
Customs tariff number (Comb. Nomenclature EU)	85363010
GTIN	4013364120570
PU	1 pc(s)

^{*)} For more detailed information, please visit www.dehn-international.com.

BLITZDUCTOR XT

BXT ML2 BE S 24 (920 224)

- LifeCheck SPD monitoring function
- Optimal protection of two single lines and the cable shield
- For use in conformity with the lightning protection zone concept at the boundaries from $0_A -2$ and higher



Figure without obligation

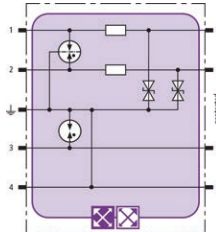

Basic circuit diagram BXT ML2 BE S 24

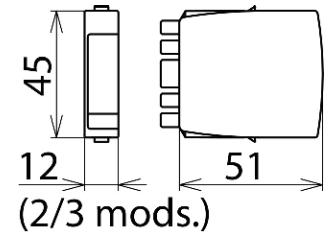

Dimension drawing BXT ML2 BE S 24

Space-saving combined lightning current and surge arrester module with LifeCheck feature for protecting two single lines sharing a common reference potential as well as unbalanced interfaces, with direct or indirect shield earthing. If LifeCheck detects thermal or electrical overload, the arrester has to be replaced. This status is indicated contactlessly by the DEHNrecord LC / SCM / MCM reader.

Type	BXT ML2 BE S 24
Part No.	920 224
SPD monitoring system	LifeCheck
SPD class	TYPE 1 PI
Nominal voltage (U_N)	24 V
Max. continuous operating voltage (d.c.) (U_c)	33 V
Max. continuous operating voltage (a.c.) (U_c)	23.3 V
Nominal current at 45 °C (I_L)	0.75 A
D1 Total lightning impulse current (10/350 μ s) (I_{imp})	9 kA
D1 Lightning impulse current (10/350 μ s) per line (I_{imp})	2.5 kA
C2 Total nominal discharge current (8/20 μ s) (I_n)	20 kA
C2 Nominal discharge current (8/20 μ s) per line (I_n)	10 kA
Voltage protection level line-line for I_{imp} D1 (U_p)	≤ 102 V
Voltage protection level line-PG for I_{imp} D1 (U_p)	≤ 66 V
Voltage protection level line-line at 1 kV/ μ s C3 (U_p)	≤ 90 V
Voltage protection level line-PG at 1 kV/ μ s C3 (U_p)	≤ 45 V
Series resistance per line	1.8 ohm(s)
Cut-off frequency line-PG (f_c)	6.8 MHz
Capacitance line-line (C)	≤ 0.5 nF
Capacitance line-PG (C)	≤ 1.0 nF
Operating temperature range (T_U)	-40 °C ... +80 °C
Degree of protection (with plugged-in protection module)	IP 20
Pluggable into	BXT BAS / BSP BAS 4 base part
Earthing via	BXT BAS / BSP BAS 4 base part
Enclosure material	polyamide PA 6.6
Colour	yellow
Test standards	IEC 61643-21 / EN 61643-21, UL 497B
Approvals	CSA, EAC, ATEX, IECEx, CSA & USA Hazloc, SIL
SIL classification	up to SIL3 [*]
ATEX approvals	DEKRA 11ATEX0089 X: II 3 G Ex nA IIC T4 Gc
IECEx approvals	DEK 11.0032X: Ex nA IIC T4 Gc
CSA & USA Hazloc approvals (1)	2516389: Class I Div. 2 GP A, B, C, D T4
CSA & USA Hazloc approvals (2)	2516389: Class I Zone 2, AEx nA IIC T4
Weight	37 g
Customs tariff number (Comb. Nomenclature EU)	85363010
GTIN	4013364117785
PU	1 pc(s)

*For more detailed information, please visit www.dehn-international.com.

BLITZDUCTOR XT

BXT ML2 BD S 24 (920 244)

- LifeCheck SPD monitoring function
- Optimal protection of one pair and the cable shield
- For installation in conformity with the lightning protection zone concept at the boundaries from $0_A -2$ and higher



Figure without obligation

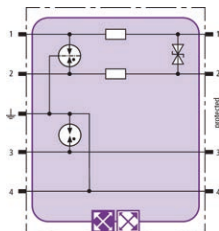

Basic circuit diagram BXT ML2 BD S 24

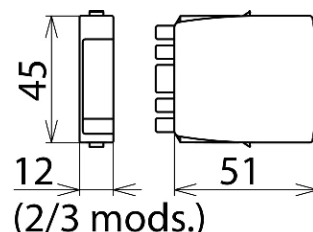

Dimension drawing BXT ML2 BD S 24

Space-saving combined lightning current and surge arrester module with LifeCheck feature for protecting one pair of unearthed balanced interfaces, with direct or indirect shield earthing. If LifeCheck detects thermal or electrical overload, the arrester has to be replaced. This status is indicated contactlessly by the DEHNrecord LC / SCM / MCM reader.

Type	BXT ML2 BD S 24
Part No.	920 244
SPD monitoring system	LifeCheck
SPD class	TYPE I PI
Nominal voltage (U_N)	24 V
Max. continuous operating voltage (d.c.) (U_c)	33 V
Max. continuous operating voltage (a.c.) (U_c)	23.3 V
Nominal current at 45 °C (I_L)	1.0 A
D1 Total lightning impulse current (10/350 μ s) (I_{imp})	9 kA
D1 Lightning impulse current (10/350 μ s) per line (I_{imp})	2.5 kA
C2 Total nominal discharge current (8/20 μ s) (I_n)	20 kA
C2 Nominal discharge current (8/20 μ s) per line (I_n)	10 kA
Voltage protection level line-line for I_{imp} D1 (U_p)	≤ 52 V
Voltage protection level line-PG for I_{imp} D1 (U_p)	≤ 550 V
Voltage protection level line-line at 1 kV/ μ s C3 (U_p)	≤ 45 V
Voltage protection level line-PG at 1 kV/ μ s C3 (U_p)	≤ 550 V
Series resistance per line	1.0 ohm(s)
Cut-off frequency line-line (f_c)	7.8 MHz
Capacitance line-line (C)	≤ 1.0 nF
Capacitance line-PG (C)	≤ 25 pF
Operating temperature range (T_U)	-40 °C ... +80 °C
Degree of protection (with plugged-in protection module)	IP 20
Pluggable into	BXT BAS / BSP BAS 4 base part
Earthing via	BXT BAS / BSP BAS 4 base part
Enclosure material	polyamide PA 6.6
Colour	yellow
Test standards	IEC 61643-21 / EN 61643-21
Approvals	CSA, EAC, ATEX, IECEx, CSA & USA Hazloc, SIL
SIL classification	up to SIL3 ^{*)}
ATEX approvals	DEKRA 11ATEX0089 X: II 3 G Ex nA IIC T4 Gc
IECEx approvals	DEK 11.0032X: Ex nA IIC T4 Gc
CSA & USA Hazloc approvals (1)	2516389: Class I Div. 2 GP A, B, C, D T4
CSA & USA Hazloc approvals (2)	2516389: Class I Zone 2, AEx nA IIC T4
Weight	21 g
Customs tariff number (Comb. Nomenclature EU)	85363010
GTIN	4013364117792
PU	1 pc(s)

^{*)} For more detailed information, please visit www.dehn-international.com.

BLITZDUCTOR XT

BXT ML2 BD S 48 (920 245)

- LifeCheck SPD monitoring function
- Optimal protection of one pair and the cable shield
- For installation in conformity with the lightning protection zone concept at the boundaries from $0_A -2$ and higher



Figure without obligation

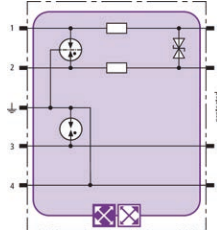

Basic circuit diagram BXT ML2 BD S 24 48

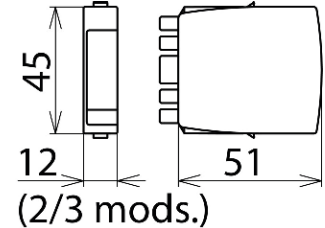

Dimension drawing BXT ML2 BD S 48

Space-saving combined lightning current and surge arrester module with LifeCheck feature for protecting one pair of unearthed balanced interfaces, with direct or indirect shield earthing. If LifeCheck detects thermal or electrical overload, the arrester has to be replaced. This status is indicated contactlessly by the DEHNrecord LC / SCM / MCM reader.

Type	BXT ML2 BD S 48
Part No.	920 245
SPD monitoring system	LifeCheck
SPD class	TYPE 1 PE
Nominal voltage (U_N)	48 V
Max. continuous operating voltage (d.c.) (U_c)	54 V
Max. continuous operating voltage (a.c.) (U_c)	38.1 V
Nominal current at 45 °C (I_L)	1.0 A
D1 Total lightning impulse current (10/350 μ s) (I_{imp})	9 kA
D1 Lightning impulse current (10/350 μ s) per line (I_{imp})	2.5 kA
C2 Total nominal discharge current (8/20 μ s) (I_n)	20 kA
C2 Nominal discharge current (8/20 μ s) per line (I_n)	10 kA
Voltage protection level line-line for I_{imp} D1 (U_p)	≤ 80 V
Voltage protection level line-PG for I_{imp} D1 (U_p)	≤ 550 V
Voltage protection level line-line at 1 kV/ μ s C3 (U_p)	≤ 70 V
Voltage protection level line-PG at 1 kV/ μ s C3 (U_p)	≤ 550 V
Series resistance per line	1.0 ohm(s)
Cut-off frequency line-line (f_c)	8.7 MHz
Capacitance line-line (C)	≤ 0.7 nF
Capacitance line-PG (C)	≤ 25 pF
Operating temperature range (T_U)	-40 °C ... +80 °C
Degree of protection (with plugged-in protection module)	IP 20
Pluggable into	BXT BAS / BSP BAS 4 base part
Earthing via	BXT BAS / BSP BAS 4 base part
Enclosure material	polyamide PA 6.6
Colour	yellow
Test standards	IEC 61643-21 / EN 61643-21
Approvals	CSA, EAC, ATEX, IECEx, CSA & USA Hazloc, SIL
SIL classification	up to SIL3 ^{*)}
ATEX approvals	DEKRA 11ATEX0089 X: II 3 G Ex nA IIC T4 Gc
IECEx approvals	DEK 11.0032X: Ex nA IIC T4 Gc
CSA & USA Hazloc approvals (1)	2516389: Class I Div. 2 GP A, B, C, D T4
CSA & USA Hazloc approvals (2)	2516389: Class I Zone 2, AEx nA IIC T4
Weight	36 g
Customs tariff number (Comb. Nomenclature EU)	85363010
GTIN	4013364118386
PU	1 pc(s)

^{*)} For more detailed information, please visit www.dehn-international.com.

BLITZDUCTOR XT

BXT ML2 BD HFS 5 (920 271)

- LifeCheck SPD monitoring function
- Minimal signal interference
- For installation in conformity with the lightning protection zone concept at the boundaries from $0_A -2$ and higher



Figure without obligation

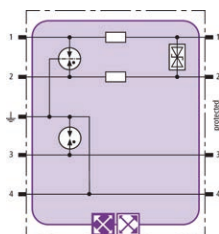

Basic circuit diagram BXT ML2 BD HFS

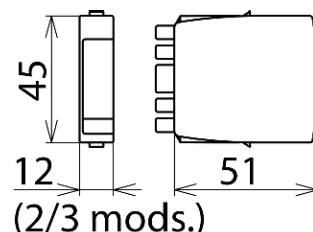

Dimension drawing BXT ML2 BD HFS

Space-saving combined lightning current and surge arrester module with LifeCheck feature for protecting one pair of unearthed high-frequency bus systems or video transmission systems, with direct or indirect shield earthing. If LifeCheck detects thermal or electrical overload, the arrester has to be replaced. This status is indicated contactlessly by the DEHNrecord LC / SCM / MCM reader.

Type	BXT ML2 BD HFS 5
Part No.	920 271
SPD monitoring system	LifeCheck
SPD class	TYPE 1 PI
Nominal voltage (U_N)	5 V
Max. continuous operating voltage (d.c.) (U_C)	6.0 V
Max. continuous operating voltage (a.c.) (U_C)	4.2 V
Nominal current at 45 °C (I_L)	1.0 A
D1 Total lightning impulse current (10/350 μ s) (I_{imp})	9 kA
D1 Lightning impulse current (10/350 μ s) per line (I_{imp})	2.5 kA
C2 Total nominal discharge current (8/20 μ s) (I_n)	20 kA
C2 Nominal discharge current (8/20 μ s) per line (I_n)	10 kA
Voltage protection level line-line for I_{imp} D1 (U_p)	≤ 25 V
Voltage protection level line-PG for I_{imp} D1 (U_p)	≤ 550 V
Voltage protection level line-line at 1 kV/ μ s C3 (U_p)	≤ 11 V
Voltage protection level line-PG at 1 kV/ μ s C3 (U_p)	≤ 550 V
Series resistance per line	1.0 ohm(s)
Cut-off frequency line-line (f_c)	100.0 MHz
Capacitance line-line (C)	≤ 25 pF
Capacitance line-PG (C)	≤ 25 pF
Operating temperature range (T_U)	-40 °C ... +80 °C
Degree of protection (with plugged-in protection module)	IP 20
Pluggable into	BXT BAS / BSP BAS 4 base part
Earthing via	BXT BAS / BSP BAS 4 base part
Enclosure material	polyamide PA 6.6
Colour	yellow
Test standards	IEC 61643-21 / EN 61643-21, UL 497B
Approvals	CSA, UL, EAC, ATEX, IECEx, CSA & USA Hazloc, SIL
SIL classification	up to SIL3 ^{*)}
ATEX approvals	DEKRA 11ATEX0089 X: II 3 G Ex nA IIC T4 Gc
IECEx approvals	DEK 11.0032X: Ex nA IIC T4 Gc
CSA & USA Hazloc approvals (1)	2516389: Class I Div. 2 GP A, B, C, D T4
CSA & USA Hazloc approvals (2)	2516389: Class I Zone 2, AEx nA IIC T4
Weight	22 g
Customs tariff number (Comb. Nomenclature EU)	85363010
GTIN	4013364117556
PU	1 pc(s)

^{*)} For more detailed information, please visit www.dehn-international.com.

BLITZDUCTOR XT

BXT ML4 BE 36 (920 336)

- LifeCheck SPD monitoring function
- Optimal protection of four single lines
- For installation in conformity with the lightning protection zone concept at the boundaries from $0_A - 2$ and higher



Figure without obligation

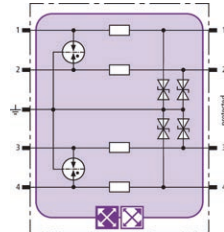

Basic circuit diagram BXT ML4 BE 36

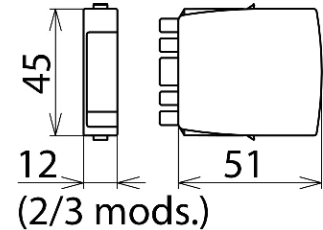

Dimension drawing BXT ML4 BE 36

Space-saving combined lightning current and surge arrester module with LifeCheck feature for protecting four single lines sharing a common reference potential as well as unbalanced interfaces. If LifeCheck detects thermal or electrical overload, the arrester has to be replaced. This status is indicated contactlessly by the DEHNrecord LC / SCM / MCM reader.

Type	BXT ML4 BE 36
Part No.	920 336
SPD monitoring system	LifeCheck
SPD class	TYPE 1 PC
Nominal voltage (U_N)	36 V
Max. continuous operating voltage (d.c.) (U_c)	45 V
Max. continuous operating voltage (a.c.) (U_c)	31 V
Nominal current at 45 °C (I_L)	1.8 A
D1 Total lightning impulse current (10/350 μ s) (I_{imp})	10 kA
D1 Lightning impulse current (10/350 μ s) per line (I_{imp})	2.5 kA
C2 Total nominal discharge current (8/20 μ s) (I_n)	20 kA
C2 Nominal discharge current (8/20 μ s) per line (I_n)	10 kA
Voltage protection level line-line for I_{imp} D1 (U_p)	≤ 140 V
Voltage protection level line-PG for I_{imp} D1 (U_p)	≤ 85 V
Voltage protection level line-line at 1 kV/ μ s C3 (U_p)	≤ 112 V
Voltage protection level line-PG at 1 kV/ μ s C3 (U_p)	≤ 56 V
Series resistance per line	0.43 ohm(s)
Cut-off frequency line-PG (f_c)	3.8 MHz
Capacitance line-line (C)	≤ 0.8 nF
Capacitance line-PG (C)	≤ 1.6 nF
Operating temperature range (T_U)	-40 °C ... +80 °C
Degree of protection (with plugged-in protection module)	IP 20
Pluggable into	BXT BAS / BSP BAS 4 base part
Earthing via	BXT BAS / BSP BAS 4 base part
Enclosure material	polyamide PA 6.6
Colour	yellow
Test standards	IEC 61643-21 / EN 61643-21
Approvals	UL, EAC, ATEX, IECEx, CSA & USA Hazloc, SIL
SIL classification	up to SIL3 ^{*)}
ATEX approvals	DEKRA 11ATEX0089 X: II 3 G Ex nA IIC T4 Gc
IECEx approvals	DEK 11.0032X: Ex nA IIC T4 Gc
CSA & USA Hazloc approvals (1)	2516389: Class I Div. 2 GP A, B, C, D T4
CSA & USA Hazloc approvals (2)	2516389: Class I Zone 2, AEx nA IIC T4
Weight	40 g
Customs tariff number (Comb. Nomenclature EU)	85363010
GTIN	4013364118539
PU	1 pc(s)

^{*)} For more detailed information, please visit www.dehn-international.com.

BLITZDUCTOR XT

BXT ML4 BD 24 (920 344)

- LifeCheck SPD monitoring function
- Optimal protection of two pairs
- For installation in conformity with the lightning protection zone concept at the boundaries from $0_A -2$ and higher



Figure without obligation

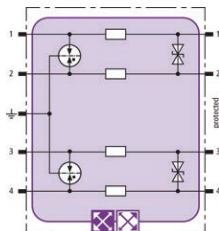

Basic circuit diagram BXT ML4 BD 24

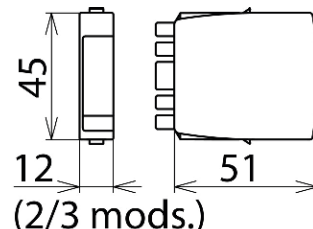

Dimension drawing BXT ML4 BD 24

Space-saving combined lightning current and surge arrester module with LifeCheck feature for protecting two pairs of unearthed balanced interfaces. If LifeCheck detects thermal or electrical overload, the arrester has to be replaced. This status is indicated contactlessly by the DEHNrecord LC / SCM / MCM reader.

Type	BXT ML4 BD 24
Part No.	920 344
SPD monitoring system	LifeCheck
SPD class	TYPE 1 Pd
Nominal voltage (U_N)	24 V
Max. continuous operating voltage (d.c.) (U_c)	33 V
Max. continuous operating voltage (a.c.) (U_c)	23.3 V
Nominal current at 45 °C (I_L)	1.0 A
D1 Total lightning impulse current (10/350 μ s) (I_{imp})	10 kA
D1 Lightning impulse current (10/350 μ s) per line (I_{imp})	2.5 kA
C2 Total nominal discharge current (8/20 μ s) (I_n)	20 kA
C2 Nominal discharge current (8/20 μ s) per line (I_n)	10 kA
Voltage protection level line-line for I_{imp} D1 (U_p)	≤ 52 V
Voltage protection level line-PG for I_{imp} D1 (U_p)	≤ 550 V
Voltage protection level line-line at 1 kV/ μ s C3 (U_p)	≤ 45 V
Voltage protection level line-PG at 1 kV/ μ s C3 (U_p)	≤ 550 V
Series resistance per line	1.0 ohm(s)
Cut-off frequency line-line (f_c)	7.8 MHz
Capacitance line-line (C)	≤ 1.0 nF
Capacitance line-PG (C)	≤ 16 pF
Operating temperature range (T_U)	-40 °C ... +80 °C
Degree of protection (with plugged-in protection module)	IP 20
Pluggable into	BXT BAS / BSP BAS 4 base part
Earthing via	BXT BAS / BSP BAS 4 base part
Enclosure material	polyamide PA 6.6
Colour	yellow
Test standards	IEC 61643-21 / EN 61643-21, UL 497B
Approvals	CSA, UL, EAC, ATEX, IECEx, CSA & USA Hazloc, SIL
SIL classification	up to SIL3 [*]
ATEX approvals	DEKRA 11ATEX0089 X: II 3 G Ex nA IIC T4 Gc
IECEx approvals	DEK 11.0032X: Ex nA IIC T4 Gc
CSA & USA Hazloc approvals (1)	2516389: Class I Div. 2 GP A, B, C, D T4
CSA & USA Hazloc approvals (2)	2516389: Class I Zone 2, AEx nA IIC T4
Weight	37 g
Customs tariff number (Comb. Nomenclature EU)	85363010
GTIN	4013364108981
PU	1 pc(s)

*For more detailed information, please visit www.dehn-international.com.

BLITZDUCTOR XT

BXT ML4 BD HF 5 (920 371)

- LifeCheck SPD monitoring function
- Minimal signal interference
- For installation in conformity with the lightning protection zone concept at the boundaries from $0_A -2$ and higher



Figure without obligation

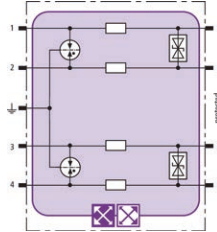

Basic circuit diagram BXT ML4 BD HF 5

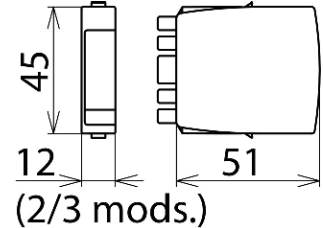

Dimension drawing BXT ML4 BD HF 5

Space-saving combined lightning current and surge arrester module with LifeCheck feature for protecting two pairs of high-frequency bus systems or video transmission systems. If LifeCheck detects thermal or electrical overload, the arrester has to be replaced. This status is indicated contactlessly by the DEHNrecord LC / SCM / MCM reader.

Type	BXT ML4 BD HF 5
Part No.	920 371
SPD monitoring system	LifeCheck
SPD class	TYPE 1 PE
Nominal voltage (U_N)	5 V
Max. continuous operating voltage (d.c.) (U_c)	6.0 V
Max. continuous operating voltage (a.c.) (U_c)	4.2 V
Nominal current at 45 °C (I_L)	1.0 A
D1 Total lightning impulse current (10/350 μ s) (I_{imp})	10 kA
D1 Lightning impulse current (10/350 μ s) per line (I_{imp})	2.5 kA
C2 Total nominal discharge current (8/20 μ s) (I_n)	20 kA
C2 Nominal discharge current (8/20 μ s) per line (I_n)	10 kA
Voltage protection level line-line for I_{imp} D1 (U_p)	≤ 25 V
Voltage protection level line-PG for I_{imp} D1 (U_p)	≤ 550 V
Voltage protection level line-line at 1 kV/ μ s C3 (U_p)	≤ 11 V
Voltage protection level line-PG at 1 kV/ μ s C3 (U_p)	≤ 550 V
Series resistance per line	1.0 ohm(s)
Cut-off frequency line-line (f_c)	100.0 MHz
Capacitance line-line (C)	≤ 25 pF
Capacitance line-PG (C)	≤ 16 pF
Operating temperature range (T_U)	-40 °C ... +80 °C
Degree of protection (with plugged-in protection module)	IP 20
Pluggable into	BXT BAS / BSP BAS 4 base part
Earthing via	BXT BAS / BSP BAS 4 base part
Enclosure material	polyamide PA 6.6
Colour	yellow
Test standards	IEC 61643-21 / EN 61643-21, UL 497B
Approvals	CSA, UL, EAC, ATEX, IECEx, CSA & USA Hazloc, SIL
SIL classification	up to SIL3 [*]
ATEX approvals	DEKRA 11ATEX0089 X: II 3 G Ex nA IIC T4 Gc
IECEx approvals	DEK 11.0032X: Ex nA IIC T4 Gc
CSA & USA Hazloc approvals (1)	2516389: Class I Div. 2 GP A, B, C, D T4
CSA & USA Hazloc approvals (2)	2516389: Class I Zone 2, AEx nA IIC T4
Weight	24 g
Customs tariff number (Comb. Nomenclature EU)	85363010
GTIN	4013364109094
PU	1 pc(s)

^{*}For more detailed information, please visit www.dehn-international.com.

BLITZDUCTOR XT

BXT BAS (920 300)

- Four-pole version for universal use with all types of BSP and BXT / BXTU protection modules
- No signal interruption if the protection module is removed
- Universal design without protection elements



Figure without obligation

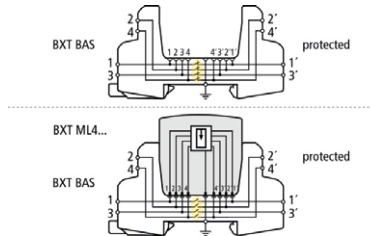

Basic circuit diagram with and without plugged-in module

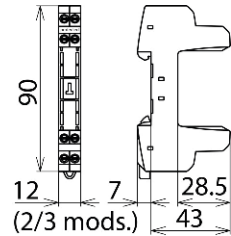

Dimension drawing BXT BAS

The BLITZDUCTOR XT base part is an extremely space-saving and universal four-pole feed-through terminal for the insertion of a protection module without signal disconnection if the protection module is removed. The snap-in mechanism at the supporting foot of the base part allows the protection module to be safely earthed via the DIN rail. Since no components of the protective circuit are situated in the base part, maintenance is only required for the protection modules.

Type Part No.	BXT BAS 920 300
Operating temperature range (T _U)	-40 °C ... +80 °C
Degree of protection	IP 20
For mounting on	35 mm DIN rails acc. to EN 60715
Connection (input / output)	screw / screw
Signal disconnection	no
Cross-sectional area, solid	0.08-4 mm ²
Cross-sectional area, flexible	0.08-2.5 mm ²
Tightening torque (terminals)	0.4 Nm
Earthing via	35 mm DIN rails acc. to EN 60715
Enclosure material	polyamide PA 6.6
Colour	yellow
ATEX approvals	DEKRA 11ATEX0089 X: II 3 G Ex nA IIC T4 Gc ^{*)}
IECEX approvals	DEK 11.0032X: Ex nA IIC T4 Gc ^{*)}
Approvals	CSA, UL, EAC, ATEX, IECEX ^{*)}
Weight	34 g
Customs tariff number (Comb. Nomenclature EU)	85369010
GTIN	4013364109179
PU	1 pc(s)

^{*)} only in connection with an approved protection module

DEHNgate

DGA G SMA (929 039)

- Compact dimensions
- Extremely wide transmission range
- For installation in conformity with the lightning protection zone concept at the boundaries from $0_B - 1$ and higher



Figure without obligation

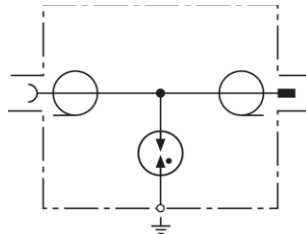

Basic circuit diagram DGA G SMA



Dimension drawing DGA G SMA

Surge arrester for remote supply with integrated gas discharge tube. Ideally suited for wireless applications for the coaxial interfaces of devices and antennas.

Available with SMA, BNC or N connection for bushing installation.

Type Part No.	DGA G SMA 929 039
SPD class	TYPE2
Max. continuous operating voltage (d.c.) (U_c)	135 V
Nominal current (I_n)	2 A
Max. transmission capacity	60 W
D1 Lightning impulse current (10/350 μ s) (I_{imp})	1 kA
C2 Nominal discharge current (8/20 μ s) (I_n)	5 kA
Voltage protection level for I_n C2 (U_p)	≤ 700 V
Frequency range	0-5.8 GHz
Insertion loss	≤ 0.2 dB
Return loss (d.c. - 3 GHz)	≥ 20 dB
Return loss (3 GHz-5.8 GHz)	≥ 18 dB
Characteristic impedance (Z)	50 ohms
Operating temperature range (T_u)	-40 °C ... +85 °C
Degree of protection (if lines are connected)	IP 65
Connection	SMA socket / SMA plug
Earthing via	bushing ($\varnothing 11.2$ mm)
Enclosure material	gold-plated brass
Colour	gold
Test standards	IEC 61643-21 / EN 61643-21
Weight	24 g
Customs tariff number (Comb. Nomenclature EU)	85366910
GTIN	4013364135185
PU	1 pc(s)

DEHNrapid

DRL RD 24 (907 442)

- Low voltage protection level line/line for protecting terminal equipment
- Energy-coordinated with DRL plug-in SPD block
- For installation in conformity with the lightning protection zone concept at the boundaries from 1 – 2 and higher



Figure without obligation

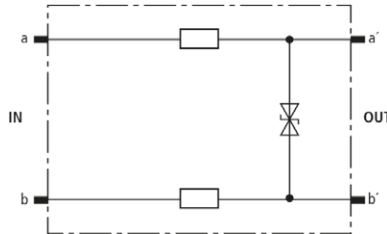

Basic circuit diagram DRL RD 24

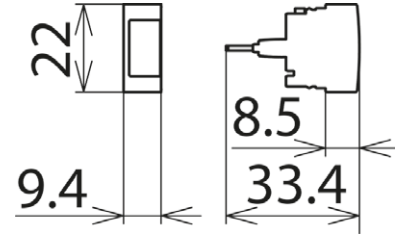

Dimension drawing DRL RD 24

Protective plug (one pair), energy-coordinated with DRL plug-in SPD block, for use as single-stage protective device for terminal equipment. Low voltage protection level line-line for floating interfaces. To be mounted into EF 10 DRL. Installation recommended only in combination with DRL plug-in SPD block.

Type Part No.	DRL RD 24 907 442
SPD class	TYPE 2 PT
Nominal voltage (U_N)	24 V
Max. continuous operating voltage (d.c.) (U_c)	28 V
Max. continuous operating voltage (a.c.) (U_c)	19.5 V
Nominal current (I_n)	0.4 A
D1 Total lightning impulse current (10/350 μ s) in combination with DRL 10 B... (I_{imp})	5 kA
D1 Lightning impulse current (10/350 μ s) per line in combination with DRL 10 B... (I_{imp})	2.5 kA
C2 Total nominal discharge current (8/20 μ s) in combination with DRL 10 B... (I_n)	10 kA
C2 Nominal discharge current (8/20 μ s) per line in combination with DRL 10 B... (I_n)	5 kA
C1 Nominal discharge current (8/20 μ s) per line without DRL 10 B... (I_n)	0.5 kA
Voltage protection level line-PG for I_{imp} D1 in combination with DRL 10 B... (U_p)	≤ 500 V
Voltage protection level line-line at 1 kV/ μ s C3 (U_p)	≤ 36 V
Series resistance per line	2.2 ohms
Cut-off frequency line-line (f_c)	5.4 MHz
Capacitance line-line (C)	≤ 1.1 nF
Operating temperature range (T_U)	-40 °C ... +80 °C
Degree of protection	IP 20 (when plugged in)
Plugs into	LSA disconnection block 2/10 or DRL 10 B ... plug-in SPD block
Enclosure material	polyamide PA 6.6
Colour	yellow
Test standards	IEC 61643-21 / EN 61643-21
Approvals	EAC
Weight	3 g
Customs tariff number (Comb. Nomenclature EU)	85363010
GTIN	4013364107700
PU	10 pc(s)

DEHNrapid

DRL 10 B 180 FSD (907 401)

- Lightning current arrester for use as plug-in SPD block with integrated LSA disconnection block function
- Visual fault indicator of the gas discharge tubes
- Can be combined to a combined lightning current and surge arrester by means of a DRL protective plug
- For installation in conformity with the lightning protection zone concept at the boundaries from $0_A -1$ and higher

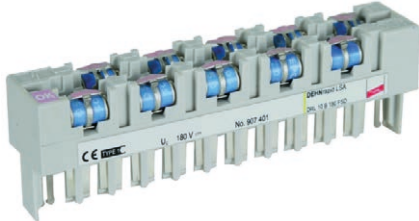
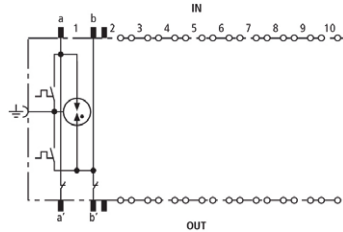
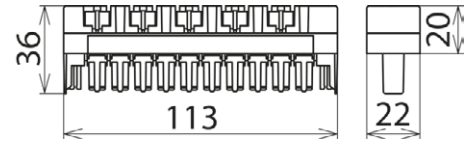

Figure without obligation



Basic circuit diagram DRL 10 B 180 FSD



Dimension drawing DRL 10 B 180 FSD

Lightning current carrying DRL plug-in SPD block (10 pairs) for almost all applications. Expandable to a combined lightning current and surge arrester by means of a DRL protective plug. The integrated disconnection block contacts allow testing, measuring and patching with plugged-in protection. The three-pole gas discharge tubes have a fail-safe function with visual fault indicator.

Type	DRL 10 B 180 FSD
Part No.	907 401
SPD class	TYPE 1 C
Fault indication	visual, colour change
Nominal voltage (U_N)	180 V
Max. continuous operating voltage (d.c.) (U_C)	180 V
Max. continuous operating voltage (a.c.) (U_C)	127 V
Nominal current (I_N)	0.4 A
D1 Total lightning impulse current (10/350 μ s) (I_{imp})	5 kA
D1 Lightning impulse current (10/350 μ s) per line (I_{imp})	2.5 kA
C2 Total nominal discharge current (8/20 μ s) (I_n)	10 kA
C2 Nominal discharge current (8/20 μ s) per line (I_n)	5 kA
Voltage protection level line-line for I_{imp} D1 (U_p)	≤ 500 V
Voltage protection level line-PG for I_{imp} D1 (U_p)	≤ 500 V
Voltage protection level line-line at 1 kV/ μ s C3 (U_p)	≤ 500 V
Voltage protection level line-PG at 1 kV/ μ s C3 (U_p)	≤ 450 V
Series resistance per line	≤ 0.005 ohms
Capacitance line-line (C)	≤ 5 pF
Capacitance line-PG (C)	≤ 5 pF
Fail-safe function	gas discharge tube with spring contacts
Operating temperature range (T_U)	-40 °C ... +80 °C
Degree of protection	IP 10
Plugs into	LSA disconnection block 2/10
Earthing via	mounting frame
Enclosure material	polyamide PA 6.6
Colour	grey
Test standards	IEC 61643-21 / EN 61643-21
Approvals	EAC
Weight	69 g
Customs tariff number (Comb. Nomenclature EU)	85363010
GTIN	4013364107564
PU	1 pc(s)

Earthing frame

EF 10 DRL (907 498)



Figure without obligation

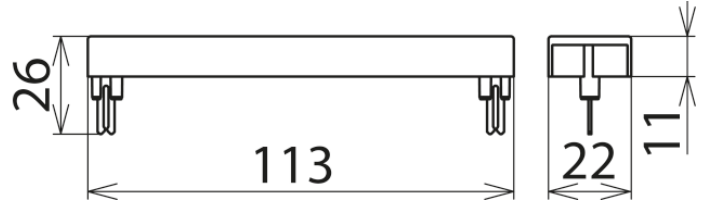

Dimension drawing EF 10 DRL

Snap-on earthing frame for earthing and installation of max. 10 DRL protective plugs. Plugs into a 10-pair disconnection block or DRL plug-in SPD block.

Type	EF 10 DRL
Part No.	907 498
Plugs into	LSA disconnection blocks or DRL plug-in SPD block
Earthing via	mounting frame or DRL plug-in SPD block
Enclosure material	polyamide PA 6.6
Colour	yellow
Weight	10 g
Customs tariff number (Comb. Nomenclature EU)	85389099
GTIN	4013364107540
PU	1 pc(s)

Surge Protection
Lightning Protection
Safety Equipment
DEHN protects.

DEHN SE
Hans-Dehn-Str. 1
Postfach 1640
92306 Neumarkt, Germany

Tel. +49 9181 906-0
Fax +49 9181 906-1100
info@dehn.de
www.dehn-international.com



www.dehn-international.com/partners

Type designations of products mentioned in this white paper which are at the same time registered trademarks are not especially marked. Hence the absence of TM or [®] markings does not indicate that the type designation is a free trade name. Nor can it be seen whether patents or utility models and other intellectual and industrial property rights exist. We reserve the right to introduce changes in performance, configuration and technology, dimensions, weights and materials in the course of technical progress. The figures are shown without obligation. Misprints, errors and modifications excepted. Reproduction in any form whatsoever is forbidden without our authorisation.